



Università Politecnica delle Marche

XVI Summer School "Francesco Turco" Impianti Industriali Meccanici
Università Politecnica delle Marche



XVI Summer School "Francesco Turco" Impianti Industriali Meccanici
Abano Terme (Padova, Italy) - 14-16 September 2011



ING-IND17
RESEARCH TEAM

Università Politecnica delle Marche

Maurizio Bevilacqua
Full professor
m.bevilacqua@univpm.it
+39 071 2204874



Mariella Leporini
Ph. D. Student
m.leporini@univpm.it
+39 071 2204101



Giancarlo Giacchetta
Full professor
g.giacchetta@univpm.it
+39 071 2204763



Claudia Paciarotti
Assistant Professor and
Researcher
c.paciarotti@univpm.it
+39 071 2204696



Barbara Marchetti
Assistant Professor and
Researcher - ECampus
barbara.marchetti@uniecampus.it
+39 071 2204101



Giovanni Mazzuto
Ph. D. Student
g.mazzuto@univpm.it
+39 071 2204880



Valentina Ciatteo
Ph. D. Student
v.ciatteo@univpm.it
+39 071 2204101



Filippo Ciarapica
Associate Professor
filippo.ciarapica@unibz.it
+39 0471 017220



XVI Summer School "Francesco Turco" Impianti Industriali Meccanici
Abano Terme (Padova, Italy) - 14-16 September 2011

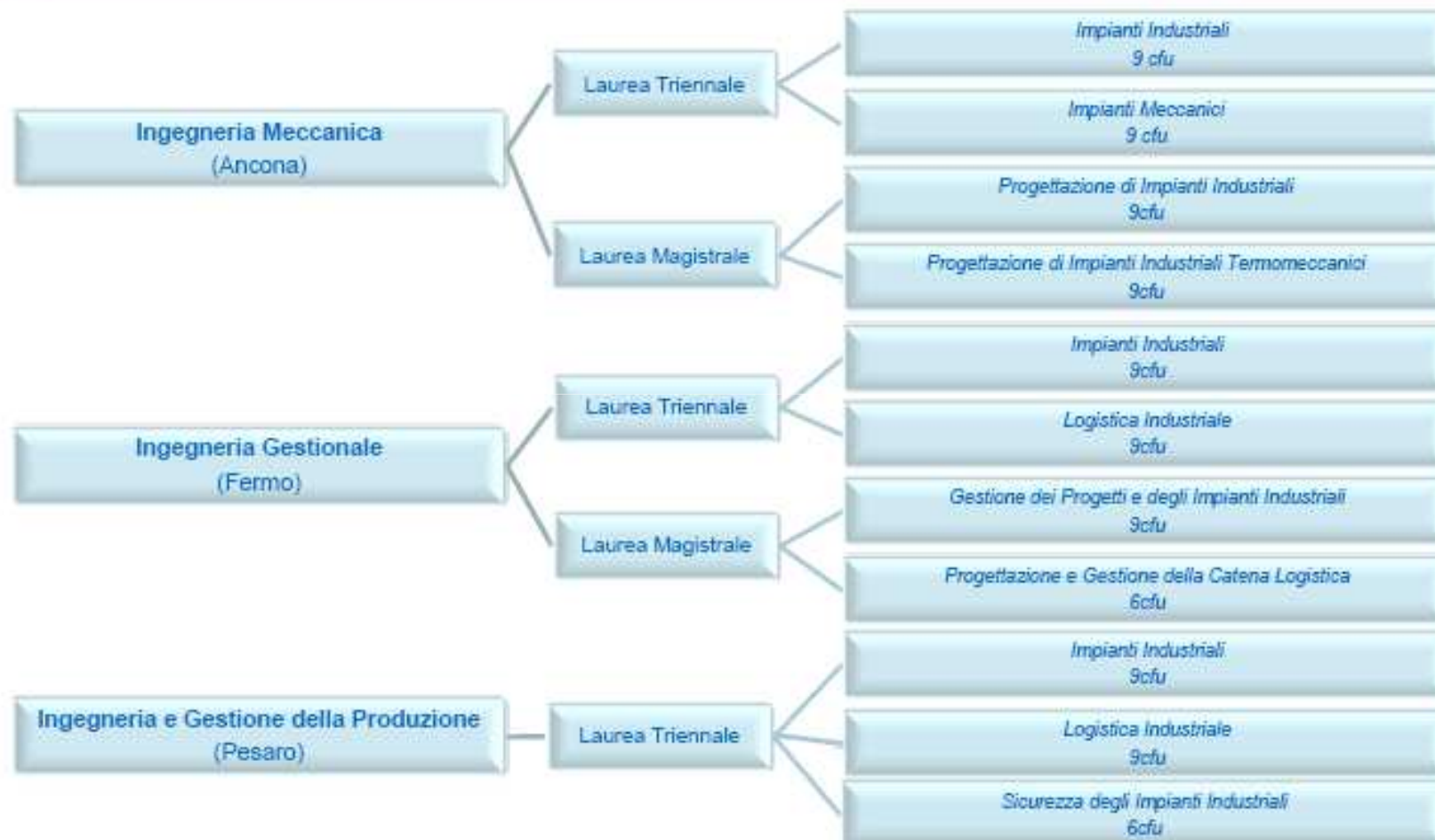

Ph. D. Faculty School, Energetica curriculum.





Università Politecnica delle Marche

RESEARCH
TOPICS

VALUE STREAM
MAPPING AND LEAN
PRODUCTION
IMPLEMENTATION in...



...healthcare

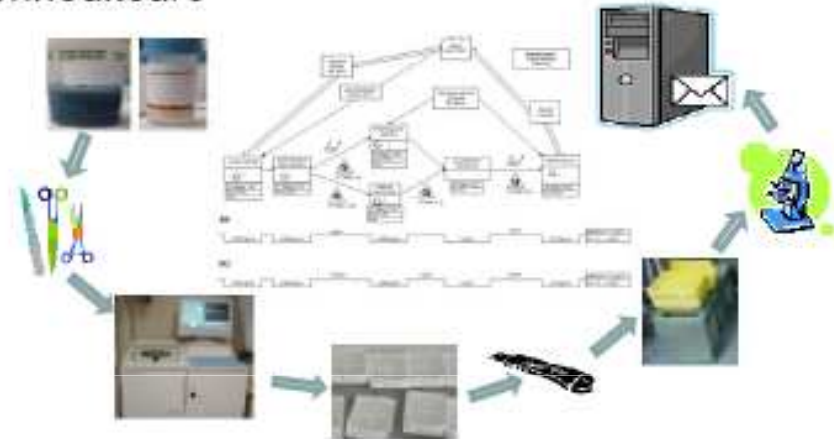

...manufacturing plants

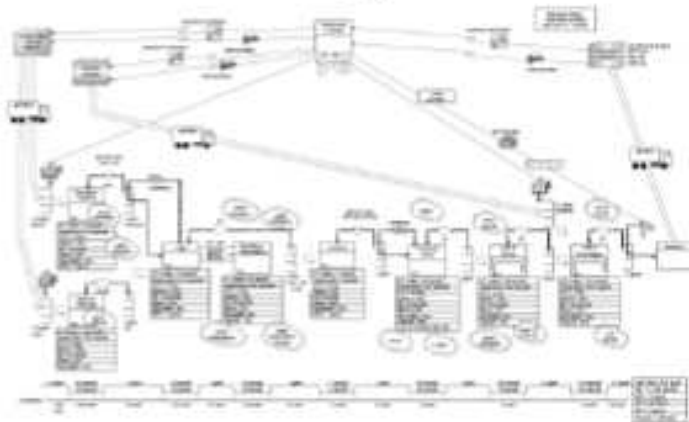

...Nonprofit organizations

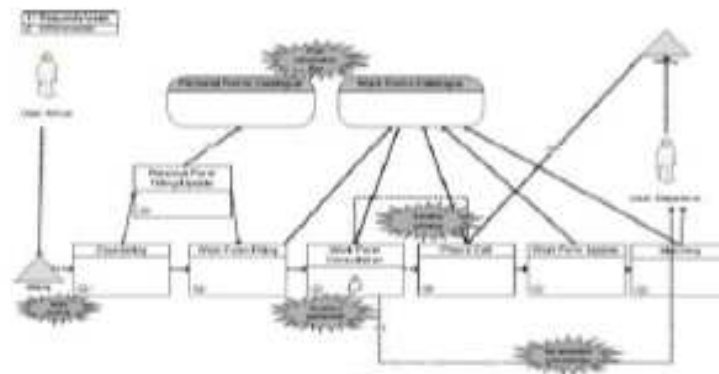

XVI Summer School "Francesco Turco" Impianti Industriali Meccanici
Abano Terme (Padova, Italy) - 14-16 September 2011



Università Politecnica delle Marche

RESEARCH
TOPICS

MULTIPHASE FLOW ANALYSIS

ING-IND17 Laboratory



*Jet pump
performance analysis
using neural network*

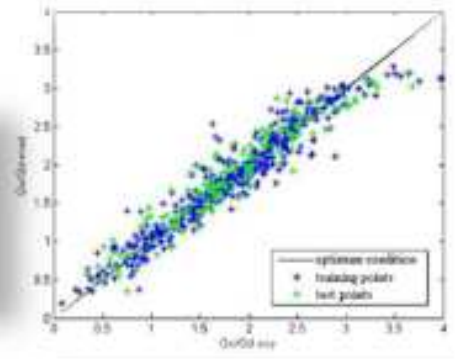
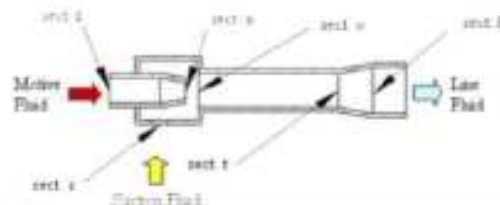

Separation systems



XVI Summer School "Francesco Turco" Impianti Industriali Meccanici
Abano Terme (Padova, Italy) - 14-16 September 2011



MULTIPHASE FLOW ANALYSIS

PAD - Pipeline Air Drying Software Development

Software Input:

- ✓ Simulation Parameters
- ✓ Pipeline Characteristics
- ✓ Operating Parameters
- ✓ Initial Water Distribution

Software Output:

- ✓ Air Vapour Concentration at Outlet

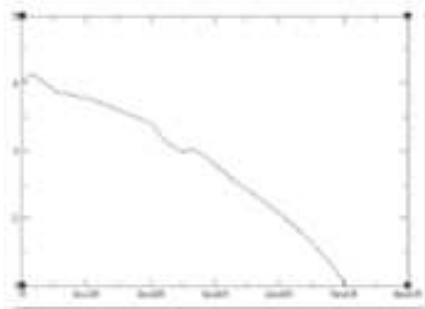

- ✓ Pressure Profile

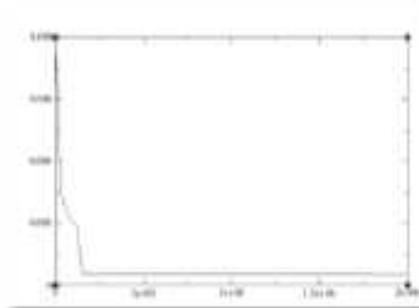

- ✓ Air Vapour Concentration Profile

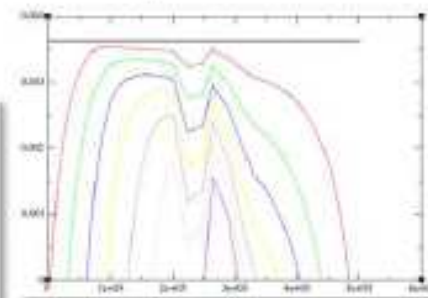

- ✓ Residual Water Profile

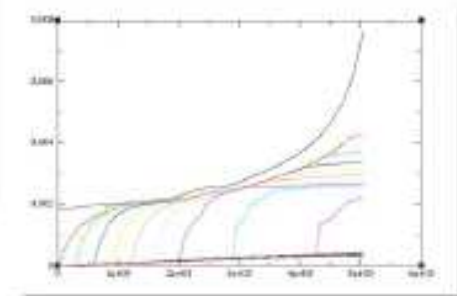



MULTIPHASE FLOW ANALYSIS

Analysis in industrial ceramic sector

Business process re-engineering

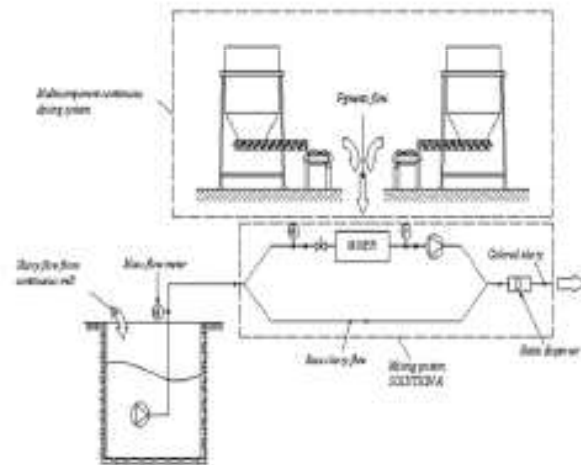

Comparison between industrial ceramic stirrers

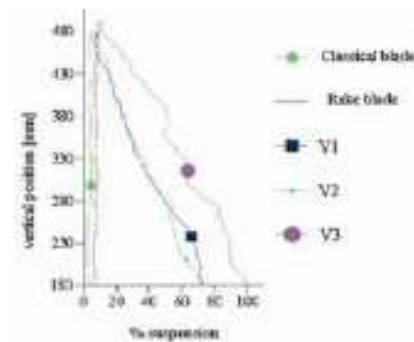
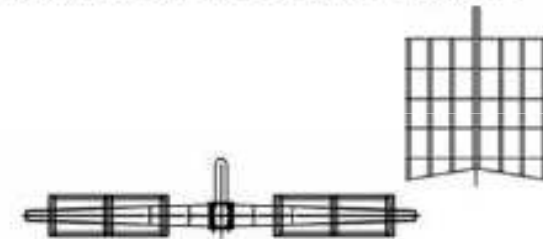



MULTIPHASE FLOW ANALYSIS



OLGA is the market-leading simulator for engineering the flow of oil, water and gas in wells, pipelines and receiving facilities.

VS



MAST is a new simulation tool used for the flow assurance analysis. It represent an alternative approach and has been developed by ENI and TEASISTEMI.

Multiphase flow through valves

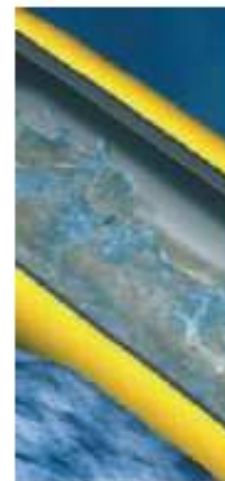
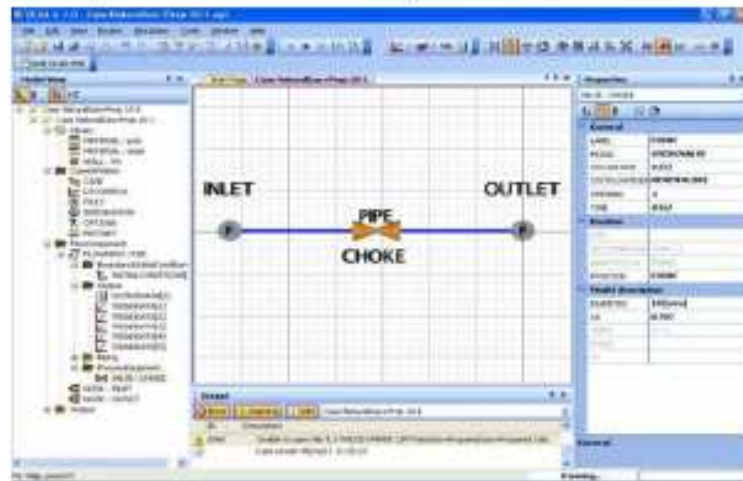

Slug Flow Analysis

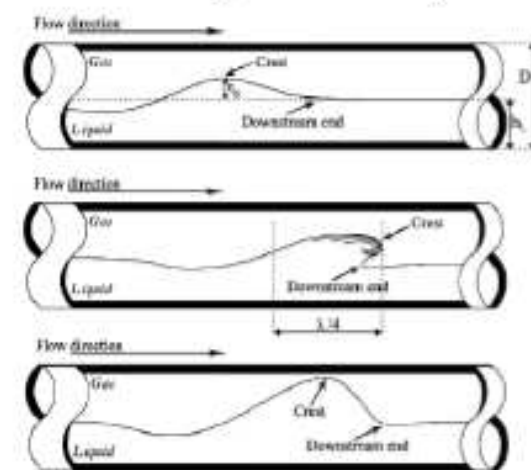



RELIABILITY AND MAINTAINABILITY ANALYSIS OF PROCESS PLANT EQUIPMENT

Maintenance policies decisions
through the
Analytic Hierarchy Process (AHP).

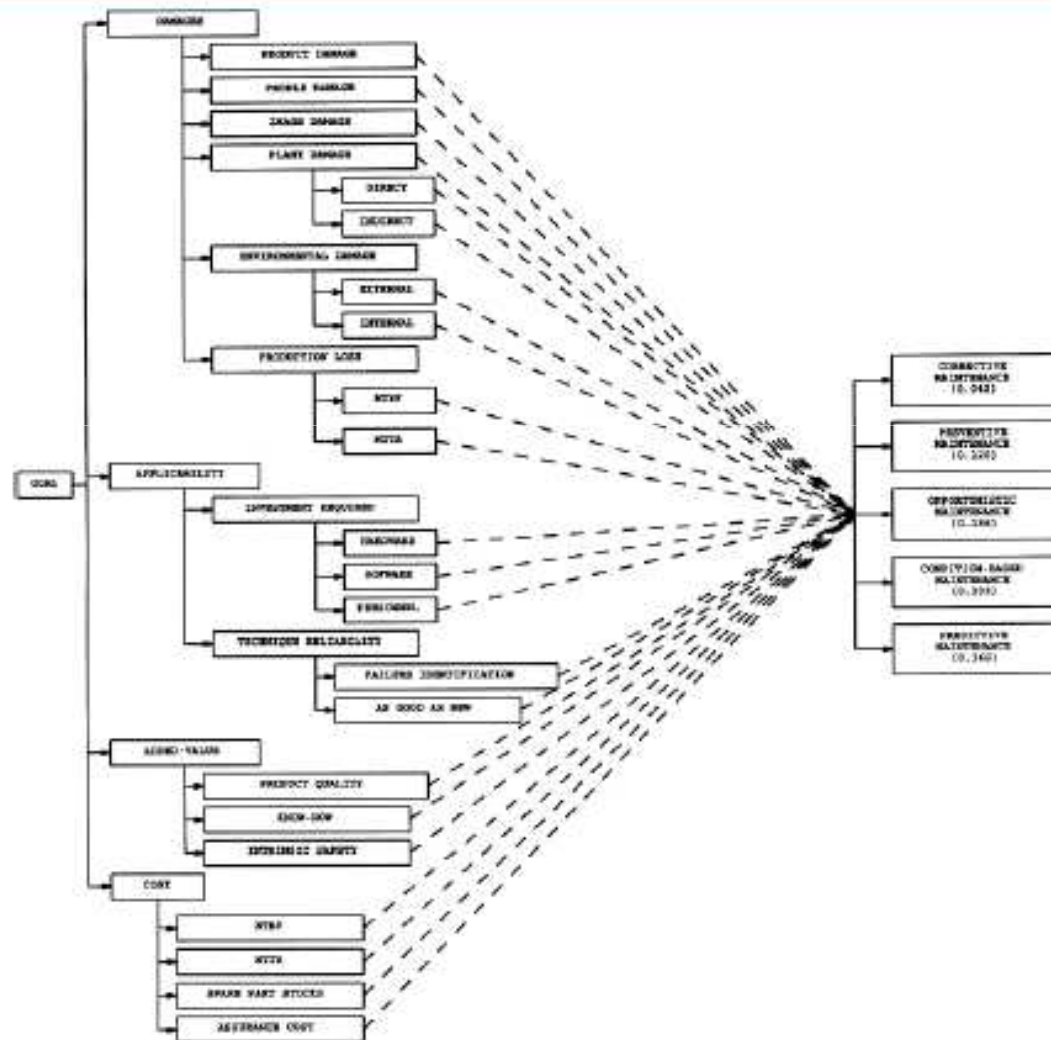



SUSTAINABILITY ANALYSIS OF PRODUCTION PROCESSES THROUGH LCA AND QFD TOOLS

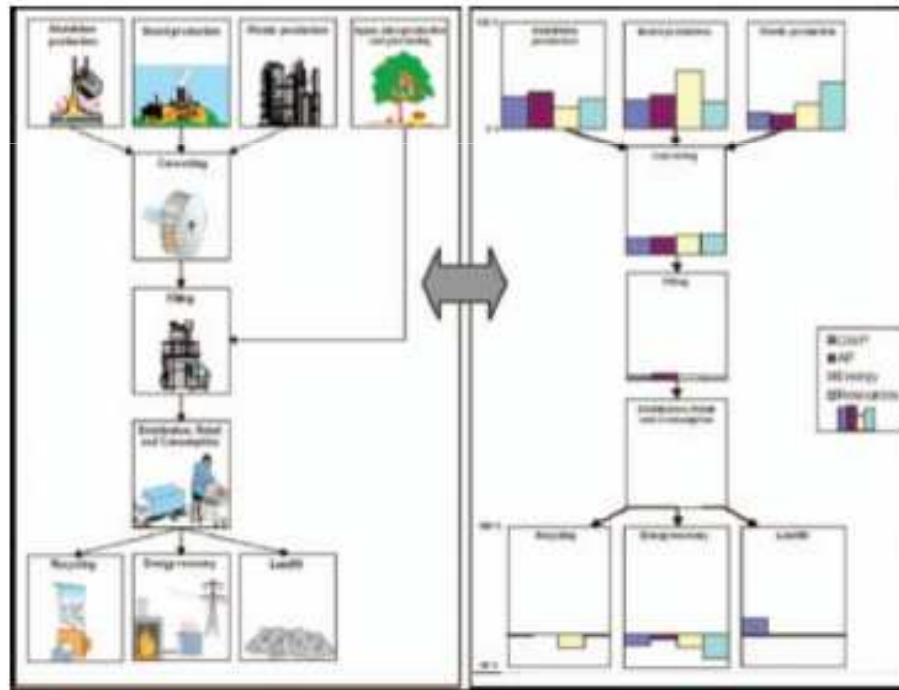

Key:
 ○ Strong positive
 ○ Positive
 × Negative
 ✖ Strong negative

		Engineering Characteristics "ECs"								
		Produce recyclable beverage cartons	Produce cartons which weigh less	Replace glass fibre	Use easily recyclable materials	Use new materials coming from renewable resources	Following Design for Disassembly methodology	Produce recyclable beverage cartons	Replacing CFC	Replacing inkjet
What?	Reduce the quantity of the material required to make the product (aluminium, paper and plastic)	9	1	0		1	1		1	
	Reduce the waste of packaging material during the production stages (Corrugating)	9	1		1		1			
	Improve the energy efficiency of the processes	3				1	1			
	Optimize the transport and material handling stages	1	0	3				3	3	
	Favour the recycling of the used cartons	3		1	0	0	1	0	1	0
	Favour the energy recovery of the used cartons	3		1	3		1	3	1	3
	TOTAL SCORE		27	90	45	36	18	51	18	36
RELATIVE IMPORTANCE		7.6%	24.2%	12.6%	10.1%	4.9%	14.7%	4.9%	10.1%	10.1%





RISK ANALYSIS TOOLS APPLICATION TO SAFETY MANAGEMENT

F C M
u o a
z g p
z n s
y i
t i
v e

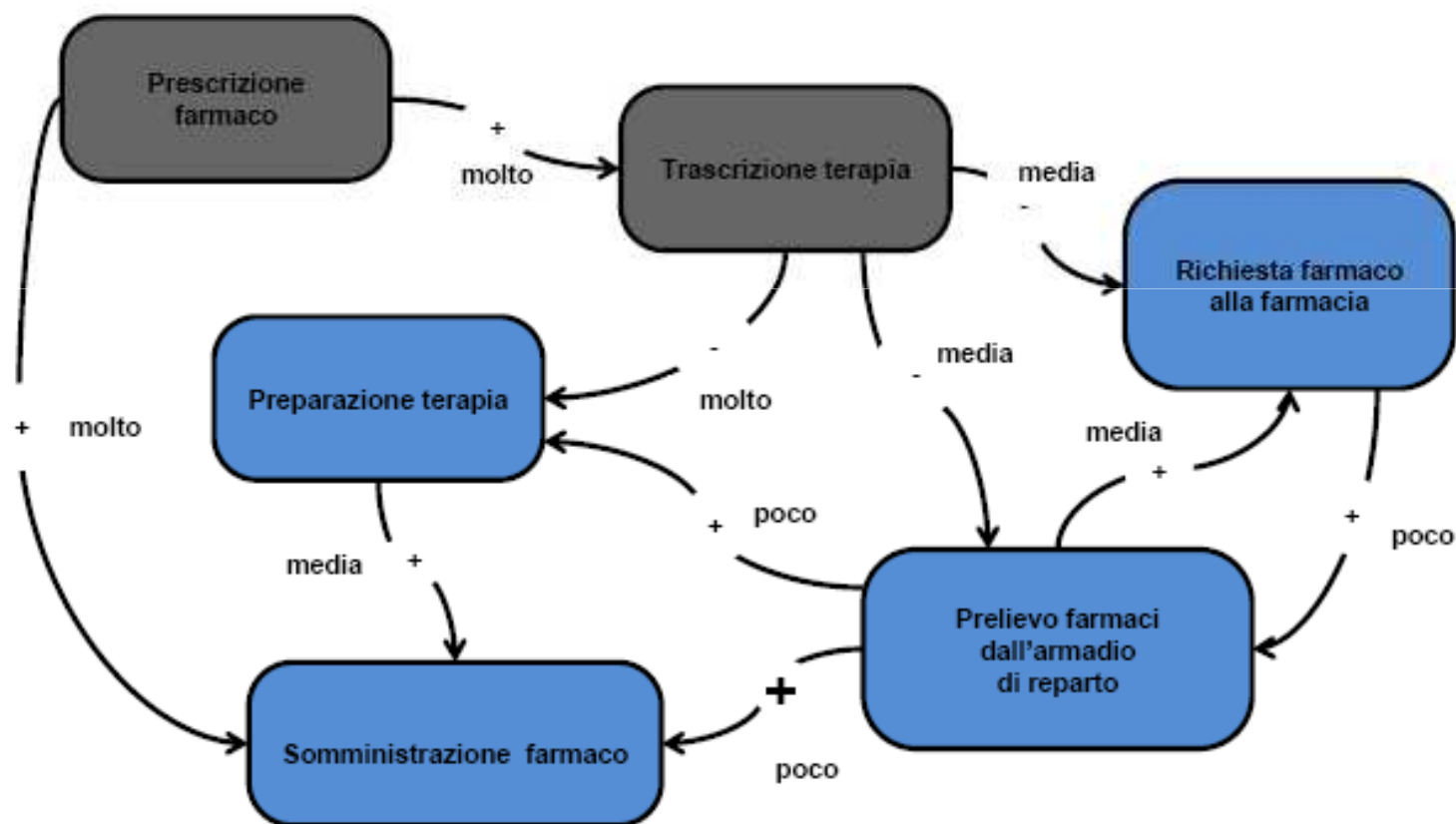



BUSINESS PROCESS REENGINEERING TECHNIQUES APPLIED TO
MANUFACTURING PROCESSES, HEALTHCARE AND SAFETY SYSTEMS

Information chain
in emergencies

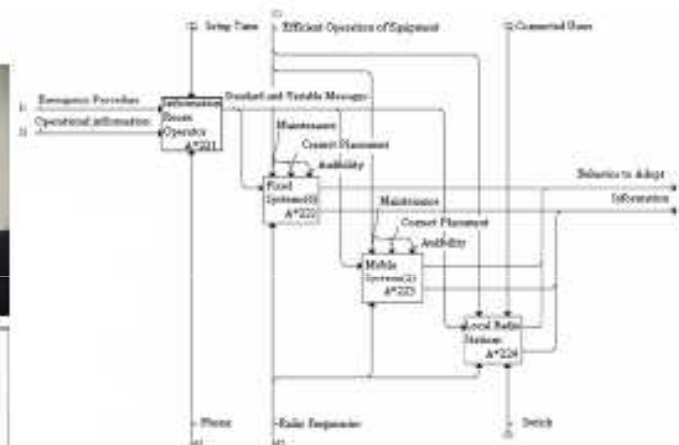
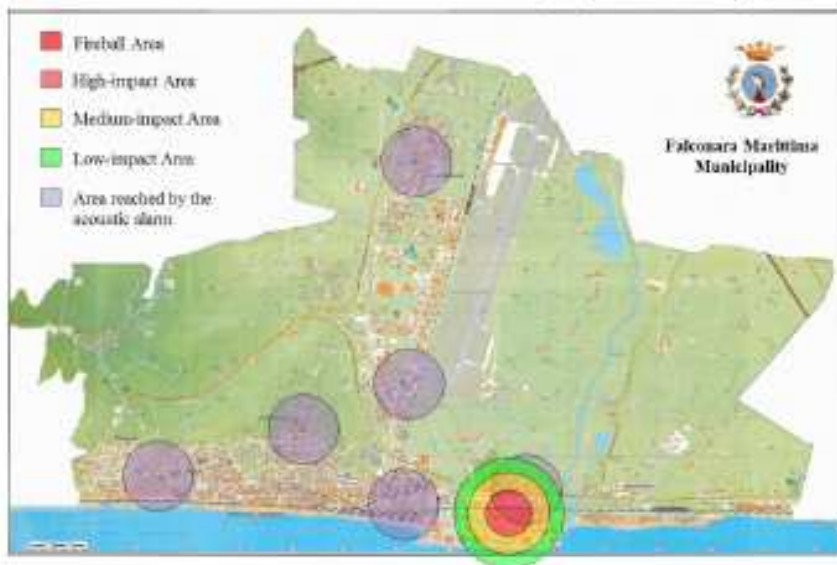

IDEF0
Technique

As-is model

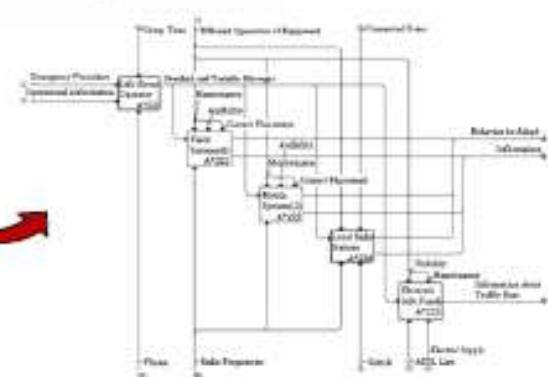

To-be model





ENERGY PRODUCTION FROM BIOMASS

Development of a self sustainable, agro-energy model for integrating the maintenance of rivers with the energy production from residual biomass, preserving river functionality and landscape, preventing flooding.

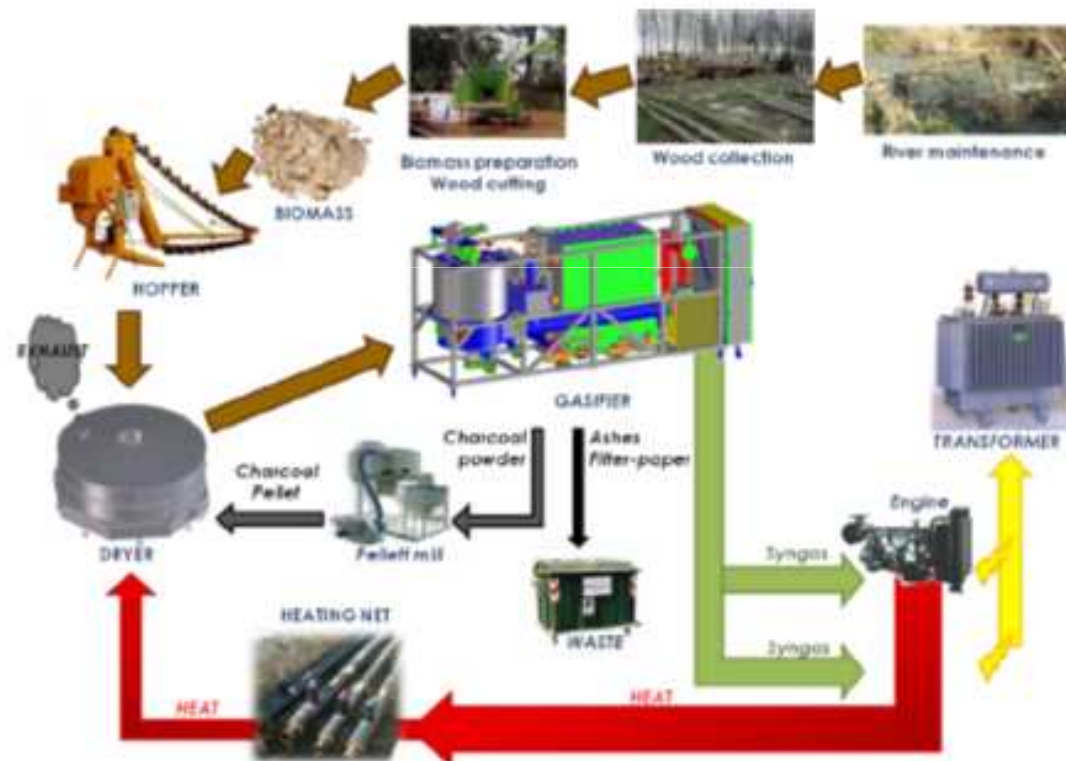



F.E. CIARAPICA; G. GIACCHETTA; C.PACIAROTTI (2008). Facility management in the healthcare sector; analysis of the Italian situation. PRODUCTION PLANNING & CONTROL. 327- 341. 19

1

PACIAROTTI C., CIATTEO V., GIACCHETTA G. (2011). Value stream mapping implementation in the third sector. OPERATIONS MANAGEMENT RESEARCH. First published online.

1

BEVILACQUA M., CORVARO F., POLONARA F. (2009). An efficiency analysis on italian thermopower plants INTERNATIONAL JOURNAL OF GLOBAL ENERGY. 32-49. Vol. 31, No. 1

2

BEVILACQUA M., CIARAPICA F.E., GIACCHETTA G. (2007). Development of a sustainable product lifecycle in manufacturing firms: a case Study INTERNATIONAL JOURNAL OF PRODUCTION RESEARCH. 4073 – 4098. 45

3

BEVILACQUA M., CIARAPICA F.E., GIACCHETTA G. (2008). Industrial and occupational ergonomics in the petrochemical process industry: a regression trees approach. ACCIDENT ANALYSIS AND PREVENTION. 1468- 1479. 40

4

CIARAPICA F.E.; GIACCHETTA G. (2009). Classification and prediction of occupational injury risk using soft computing techniques: an italian study. SAFETY SCIENCE. 36- 49. 47

4

BEVILACQUA M., CIARAPICA F.E.; GIACCHETTA G. (2009). Critical chain and risk analysis applied to high-risk industry maintenance: a case study. International JOURNAL OF PROJECT MANAGEMENT. 419- 432. 27

5

BEVILACQUA M., CIARAPICA F.E., GIACCHETTA G. (2009). Business process reengineering of a supply chain and a traceability system: a case study. JOURNAL OF FOOD ENGINEERING. 13- 22. 93

5

BEVILACQUA M., CIARAPICA F.E., GIACCHETTA G. (2006). A fuzzy-qfd approach to supplier selection. JOURNAL OF PURCHASING AND SUPPLY MANAGEMENT.14-27. Vol. 12, No. 1

6

BEVILACQUA M., CIARAPICA F.E., MARCHETTI B. (2011). Integration of BPR and RFID technology in a process industry: spare parts Warehouse management analysis. Accepted for publication in INTERNATIONAL JOURNAL OF RF TECHNOLOGIES: RESEARCH AND APPLICATIONS.

7

Research Topics – Ing/Ind-17

1	2	3	4	5	6	7
Production system analysis and design	Auxiliary plant analysis and design	Processes and production technologies	Ergonomics and safety of industrial systems	Production system management	Logistics	Production system automation



Università Politecnica delle Marche

RESEARCH PROJECTS
PARTNERS
COLLABORATIONS

BOSS
HUGO BOSS



saipem



raffineria di ancona



TOMASSONI s.r.l.
Noleggio autogrù Fano



FarmaCentro
SERVIZIO LOGISTICA



ANGELINI



Tecnoconsult Engineering Construction srl

41012 Fano (PR) - Strada Nazionale Adriatica Sud, 549
Ph +39072489423-88870 Fax +3907242667



Caritas Senigallia



Drug distribution process optimization and critical events traceability.



XVI Summer School "Francesco Turco" Impianti Industriali Meccanici
Abano Terme (Padova, Italy) - 14-16 September 2011